

## POWER SEL

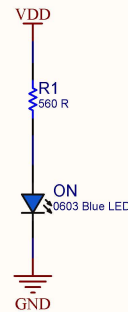

## POWER LED

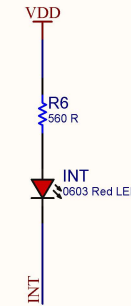

## INTERRUPT LED

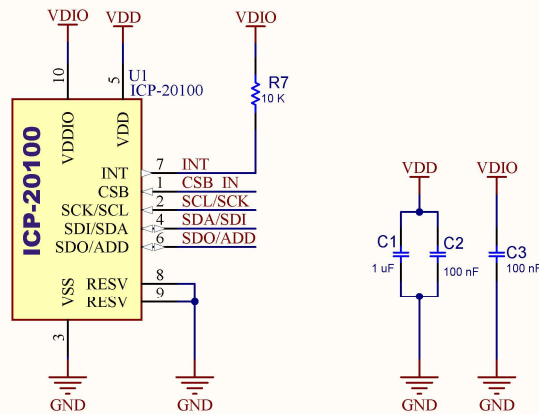

## ICP-20100

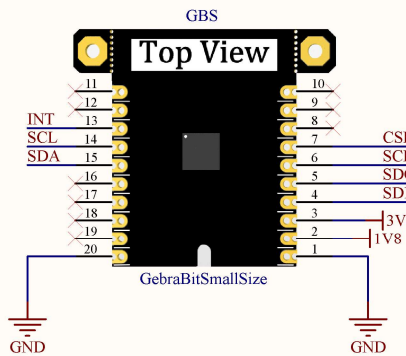

## GEBRABIT PINOUT

## I2C IS SELECTED BY DEFAULT

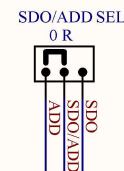
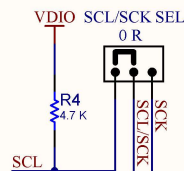
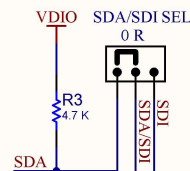
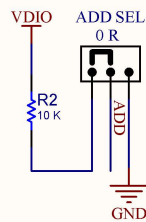
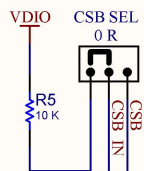

## PROTOCOL SELECTOR

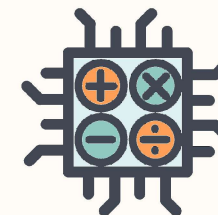

<b>Gebrabit</b>		
<a href="https://gebrabit.com/">HTTPS://GEBRABIT.COM/</a>		
Title: Gebrabit ICP-20100 Schematics		Variant: [No Variations]
Page Contents: Gebrabit ICP-20100 Circuits		Checked by: R.A
Size: SMALL	SKU CODE: GB638EN	Revision: V2.0
Date: 04/29/2023	Designed by: GEBRABIT	Sheet 1 of 1